



OPERATING GUIDE

CS[®] 1000 Stereo Power Amplifier



 Intended to alert the user to the presence of uninsulated "dangerous voltage" within the product's enclosure that may be of sufficient magnitude to constitute a risk of electric shock to persons.

 Intended to alert the user to the presence of important operating and maintenance (servicing) instructions in the literature accompanying the product.

CAUTION: Risks of electrical shock — DO NOT OPEN

CAUTION: To reduce the risk of electric shock, do not remove cover. No user serviceable parts inside. Refer Servicing to qualified service personnel.

WARNING: TO PREVENT ELECTRICAL SHOCK OR FIRE HAZARD, DO NOT EXPOSE THIS APPLIANCE TO RAIN OR MOISTURE. BEFORE USING THIS APPLIANCE, READ THE OPERATING GUIDE FOR FURTHER WARNINGS.

INSTALLATION AND CONNECTION

The Peavey CS-1000 Commercial Series Power Amplifier is designed for durability in commercial installations and the quality of performance required in studio and home applications. The CS-1000 is a dual-channel power amplifier capable of delivering more than 450 watts RMS per channel into a 4 ohm load continuously (both channels). The unit is of the standard 19" rack mount configuration requiring 7" rack height and is cooled by an automatic two-speed internal fan. All inputs and outputs are on the back panel. The front panel contains various LED indicators for power output level, DDT activation and thermal shutdown, detented/calibrated sensitivity controls and a heavy-duty mains power switch.

Mains Power Source

The CS-1000 is fitted with a single heavy-duty #14 AWG, three-conductor line cord and a conventional AC plug with a ground pin. It should be connected to a circuit capable of supporting at least 15 amps continuously or greater. This is particularly critical for sustained high power applications. If the socket used does not have a ground pin, a suitable ground lift adaptor should be used and the third wire grounded properly. Never break off the ground pin on the CS-1000. The use of an extension cord should be avoided, but if necessary, always use a three-wire type with at least a #14 AWG wire size. The use of a lighter wire will severely limit the power capability of this amplifier. Always use a qualified electrician to install any necessary electrical equipment. To prevent the risk of shock or fire hazard, always check to see that the amp is properly grounded.

Industrial and Commercial Installations

For commercial and other installations where sustained high power operation is required, the amplifiers should be mounted in a standard 19" rack. It is not necessary to leave rack space between each amplifier in the stack since the fan pulls air in from the rear and exhausts the hot air out the front. An adequate cool air supply must be provided for the amplifiers when rack mounted. The internal fan must have a source of air that is not preheated by other equipment. The amplifier will start up in low speed fan operation and will normally stay at low speed operation unless sustained high power operating levels were to occur. Then as the amplifier heat sinks heat up, the automatic thermal sensing circuitry will cause high speed operation to occur. Depending upon signal conditions and amp loading, high speed fan operation may continue or it may cycle continuously between high and low. This situation is quite normal. If cooling is inadequate due to preheated air or a reduction of air flow occurs due to blockage of the amplifier inlet/outlet ports or if the amplifier is severely overloaded or short-circuited, then the amplifier thermal sensing system may cause temporary shutdown of that particular channel. This is indicated by the illumination of the front panel high temperature LED. Depending upon available cooling air, operation should be restored in that channel relatively quickly. In any event, corrective action should be taken to determine the cause of the thermal shutdown. If the amplifier is not severely overloaded or shorted and air flow is normal in and out of the amplifier, then steps should be taken to provide a cooler environment for all the amplifiers. As a general rule, the cooler electronic equipment is operated, the longer its useful service life. You have invested in the finest equipment that money can buy, and a little care will insure long and reliable operation.

Portable Rack Mount Applications

Due to the weight of the CS-1000, we highly recommend that additional support be provided at the back panel of the amplifier whenever one or more units are installed in a portable rack mount configuration. For this purpose, two ¼-20 allen head bolts have been provided at the rear of the CS-1000. These bolts should be attached to a suitable bracketing arrangement to provide this additional support. Also, two guards have been provided on the rear panel of the CS-1200 to protect connectors, PL cans, and provide a means for routing cables. **CAUTION:** These are not handles and they should not be used to lift the unit.

Studio and Home Installation

In most low to medium power applications, the power amplifier can be mounted in any configuration. It is desirable that, if at all possible, the power amplifier be located at the top of an equipment stack. This will prevent possible overheating of sensitive equipment by the hot air rising from the power amplifier. As a general rule, most home and studio requirements will never cause high speed fan operation. If it does, however, this may indicate that you have not taken the necessary steps to provide adequate cooling. Remember - closed up in a cabinet, the CS-1000 will have severe cooling problems, even at low power levels. Again, inadvertent short circuit or sustained overload usage could also cause temporary thermal shutdown.

Input Connections

All input connections are made at the rear panel. The two ¼" jacks marked Power Amp Input (15) are wired in parallel for ease of connecting to each channel. The dual (parallel) jacks allow daisy-chaining to additional channels. If RCA-type pin jacks are required, a suitable adaptor can be used. Shielded cables must be used to minimize hum and noise pickup. The nominal input impedance is 20K ohms. This impedance represents a bridging load to the associated driving equipment and is compatible with the load requirements of most home stereo devices. The CS-1000 has an input sensitivity of 1.4V RMS (+3 dBV) for rated output with the front panel sensitivity control set at full clockwise, again allowing complete compatibility in home applications. This sensitivity rating increases as the control is turned counter-clockwise. The new sensitivity rating is indicated by the setting of the calibrated sensitivity control. It is generally wise to operate the sensitivity control at its full clockwise setting. The sensitivity control is discussed in greater detail later in this manual.

Output Connections

Two types of output connectors are provided on the rear panel of the amplifier. Two standard ¼" phone jacks wired in parallel (17) and one set of 5-way binding posts (18) are available from each channel. Due to the high currents at full output it is recommended that #16 AWG or larger wire size be used whenever possible. For extremely long runs (30' or greater), #14 AWG should be used. Smaller wire sizes will waste power and yield less than optimum results at the speaker. It is suggested that in commercial and other non-portable applications, the 5-way binding posts (18) be used instead of the ¼" phone jacks. The binding posts are industry standard and mating banana plugs are available at most electronic distributors. As with any electronic equipment, proper phase of the outputs is a necessity. A little time spent correctly identifying the wiring can save a lot of problems in the field. The CS-1000 has a continuous rating of 500 watts RMS into 4 ohms. Music power operation into 2 ohms should be considered normal and generally will not present any problems. However, continuous operation under these conditions might cause thermal shutdown, depending upon cooling air temperature. Operating into loads below 2 ohms, although safe because of electronic protection mechanisms, should be avoided.

OPERATION

The CS-1000 commercial series power amplifier is designed for maximum ease and flexibility of operation. When the unit is installed and connected as described in the previous sections, operation is as simple as turning on the mains switch (5) and turning up the sensitivity controls (1) to full clockwise setting, and then adjusting the associated mixer or preamplification equipment to supply the necessary signal levels to provide the desired output level or until the front panel DDT active LED indicator shows that the amplifier is compressing. Further increases in signal levels beyond this point will not produce any significant increase in output and could cause distortion problems.

FRONT PANEL

INPUT SENSITIVITY CONTROLS (1)

The CS-1000 employs a 31 detented, calibrated sensitivity control for each channel. These controls are labeled in a more functional manner, replacing the conventional 0 to 10 segmented circle with the actual input sensitivity ratings of the amplifier for various settings of this control. In the past, this control has often confused even the most experienced audio technician as to its purpose and usage, especially when it is simply called level (rather than sensitivity). This new labeling/calibrating technique will help to explain the need and function of these controls and the significance of the sensitivity rating. We offer the following in way of explanation: The input sensitivity rating of a power amplifier is the RMS voltage level required at the input to produce full rated power into the rated load at the output. This voltage then becomes the level at which the associated mixer must operate in order to drive the amplifier to full output. Operation at levels above this rating will cause the power amplifier to clip (produce distortion) unless the associated amplifier has a compressor or limiter to minimize this distortion. Such a system, called DDT™ (U.S. Patent #4,318,053), is included in CS-1000 power amplifiers, and the advantages should be obvious. Without DDT, the sound engineer must "ride gain" on the mixer or employ outboard compressor/limiter, in order to prevent power amp clipping.

Traditionally, the input sensitivity rating of a power amplifier receives low billing on a typical specification sheet. Often it gets lost among other interesting specs, such as damping factor, slew rate, transient intermodulation distortion and others. This rating, however, must be known to have performance visibility at the mixer. Further, the rated sensitivity on the spec sheet is only correct when the power amplifier sensitivity control is set at full clockwise or maximum setting. Any other setting increases the value. With a numbered circle from 0 to 10, this new higher value is not indicated. Thus, the CS-1000 sensitivity control is calibrated in dBV values (usually listed in typical mixer specs). The dBV values are useful, since most contemporary mixers employ LED arrays to indicate mixer output levels and are calibrated in dBV. Knowing the power amplifier sensitivity rating in dBV will allow the mixer operator to know the status of the power amplifier (whether they are clipping/compressing or not) by noting which LED on the mixer is peaking. Obviously, the LED labeled the same or closest to the sensitivity rating of the power amplifier will indicate full power output of the system. Operation below that level will indicate how much so called power amplifier headroom is left. Operation above that level will cause clipping (or compression if the DDT system is operational). Perhaps an example will be helpful: Referring to the CS-1000 face plate, you will notice that at full clockwise setting of the sensitivity control, the sensitivity rating is +3 dBV. The critical LED on the driving mixer then is the one labeled +3 dBV. It will correlate with the CS-1000 DDT active LED in that whenever the +3 dBV LED on the mixer flashes on peaks, the DDT active LED will also flash indicating full power output is achieved. If the CS-1000 sensitivity control was adjusted to a higher value, this new value would become the new correlation level on the associated mixer. There is a very simple rule regarding the setting of the sensitivity (or level) control:

"Unless there is a specific reason not to, the sensitivity control on any power amplifier should be set to full clockwise position, resulting in the minimum sensitivity rating."

There are several valid exceptions to the full clockwise rule. The first one presented here involves large systems where it is often necessary to employ many power amplifiers to supply the same signal to multiple speaker systems to achieve the necessary sound pressure levels or audience coverage. If the various power amplifiers have different sensitivity ratings and/or the various loudspeaker enclosures have different efficiency ratings, then it might be necessary to adjust certain sensitivity controls to achieve a balanced sound pressure level between the parts of the system. In this case, the loudest amplifier/speaker combinations will require those amplifier sensitivity controls to be adjusted counter-clockwise as necessary. Often in such systems, both Peavey and non-Peavey power amplifiers might be employed. In this case, as a starting point, it might be necessary to match the sensitivity rating of the Peavey power amplifier to that of the competitive power amplifier. As an example, several competitive power amplifiers on the market have a sensitivity rating of 2 volts RMS (that's +6 dBV as read from the CS-1000 sensitivity control clock). If such a competitive amplifier is used with the CS-1000, then the CS-1000 must be set to +6 dBV. A second valid exception to the rule might occur whenever a biamp system is used. This exception will be discussed later in this manual when biamped systems are presented. A third valid exception is involved in small club, church and studio applications, where the full power output capability of the power amplifier is not needed or there is no requirement for large amounts of headroom capability. Simultaneously, these applications usually require a very low noise system. In this case, it is possible to reduce the overall system noise at the expense of headroom capability by increasing the power amplifier sensitivity accordingly. As an example, if instead of a sensitivity rating of +3 dBV, we adjust the CS-1000 to a rating of +10 dBV, overall system noise will be improved by 7 dB with the resulting 7 dB decrease in system headroom. Remember, once this is done, the mixer operator cannot reestablish full headroom performance settings at the mixer. If he wants this headroom back, he must do it by resetting the power amplifier sensitivity.

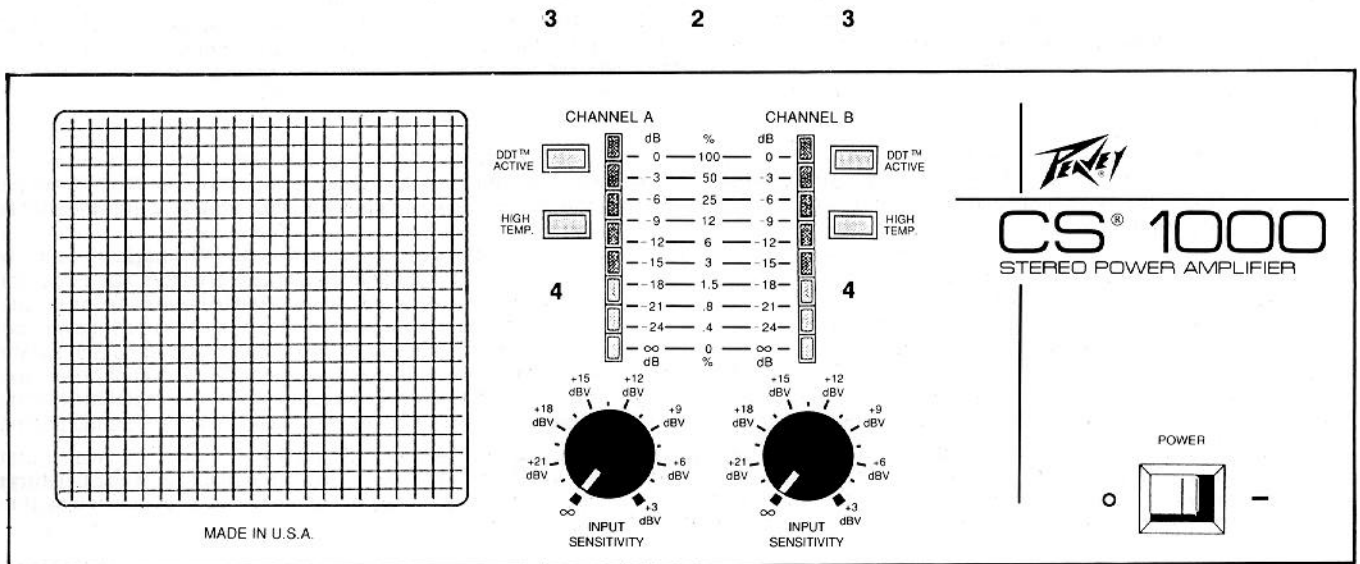

LED ARRAYS (2)

The CS-1000 has a tricolored LED array on each channel to indicate output power level. The array is calibrated in two different ways to offer maximum flexibility as to usage. In the center of the LED ladder, the calibration is percent of full power output. The top LED, labeled 100%, will flash when the CS-1000 has reached full RMS power output (500 watts RMS) on that respective channel. Operation at power output levels below 100% will naturally be indicated by lower LED readings. The lowest value indicated is 0.4% of full power, which corresponds to 2.0 watts RMS output. Operation below that power level will not be indicated since the lowest LED is calibrated at 0% or standby. This LED should be illuminated whenever the amplifier is operating with AC mains power applied under zero signal conditions. Next to each ladder the calibration is "dB below full power." This is a very convenient scale which indicates the amount of power amp headroom left for any signal condition. On this scale, the lowest LED is labeled "∞" (infinity), which is consistent with the dB system. If fault conditions exist, such as a high temp. thermal shutdown or a DC offset at the output (caused by the amplifier itself or externally induced at the input), this LED will go off and remain off until the fault is cleared. You will also notice that this LED will not light for approximately two seconds during the power-up sequence, and will go off very quickly during the power-down sequence. This is normal, indicating that the transient protection circuitry is operating properly. Should both LEDs ever fail to light after the normal power-up sequence, and no other fault conditions exist, then the mains AC power might not be applied. Such a condition might be a blown fuse. If upon replacing the fuse (with the same type and rating) it does not clear the problem, then the amplifier will require servicing by a qualified service technician.

DDT™ COMPRESSION

The CS-1000 is a compact and powerful amplifier that features a new type of dynamic compression. This compression system enables the user to maximize the performance of the amplifier/speaker combination. We have determined through much research that the compression circuitry should prevent the power amplifier from running out of headroom (clipping) and should be as simple to operate as possible to avoid undue complication for the user. This compression system is activated by our exclusive DDT compression circuitry that senses conditions that might overload the amplifier and activates compression when clipping is imminent. In other words, compression takes place whenever signal conditions exist which prevent the amplifiers from faithfully reproducing the input signal. Threshold then is clipping itself and no specific threshold control is provided. This technique effectively utilizes every precious watt available from the power amplifier. Techniques using external compressors and limiters are usually less effective, limit output power levels and require additional controls, which add complexity to an already complicated system. The DDT system is an automatic, hands-off approach to the problem of amp clipping. Because of the dynamics of music and vocals, it is quite common to activate the DDT compression circuitry almost constantly during a high level performance since this was what it is designed to do; i.e., to maximize the dynamics available from the amplifier within its power output capabilities regardless of power supply/AC line voltage variations and load impedance selection.

DDT™ ACTIVE LED'S (3)

The DDT active LED's indicate when compression is taking place. As long as gain reduction is occurring, the LED will continue to light, thereby giving a valuable indication of this unique compression function. The DDT function can be defeated on both channels simultaneously by selecting the defeat position on the DDT compression switch (7) located on the back panel of the CS-1000. When the compressor is defeated, the DDT active LED now indicates clipping, the condition where the amplifier is failing to faithfully reproduce the input signal. Defeating the DDT compressor should not be taken lightly or simply as a matter of course. Most loudspeaker systems simply can not handle the square wave power of the CS-1000 and defeating this valuable limit is only asking for trouble in the long run. Often studio engineers feel the need to defeat the DDT compressor for fear that it might color the sound in studio listening. Occasionally, external compressors/limiters are employed to automatically set the level of a particular system and thus, the unknowing technician will defeat the DDT compressor thinking it is not needed. Those are examples of not understanding the operation of the DDT circuitry. The DDT compressor is only activated when clipping is imminent. Until this occurs, it's simply a passive friend. The only reason that the defeat switch is there in the first place is to allow check-out and service technicians to evaluate the power amplifier at clipping. Valuable performance information, such as ripple and regulation, can only be assessed when an amplifier is allowed to clip. Other than those times, we strongly suggest that the DDT compressor switch be set in the active position and left that way.

THERMAL SYSTEM

The CS-1000 has a unique thermal system that employs a tunnel-like heat sink design to provide maximum cooling for the 24 power transistors (12 for each channel). A single 100 CFM fan mounted on the back panel of the amplifier provides an almost unrestricted airflow through the tunnel to provide the lowest possible operating temperature for the power devices. This approach is so efficient that even music power operation into 2 ohms will not cause a thermal shutdown unless the ambient air temperature is considerably higher than normal (above 40° C). Under normal intermittent applications, low speed fan operation will provide adequate cooling. Since the CS-1000 is a redundant two-channel amplifier, but only one fan is employed, the fan circuitry is an independent system, separately fused internally. You will notice that the heat sink components are divided horizontally. The lower half contains Channel A output transistors, while the upper half belongs to Channel B. The fan naturally provides equal cooling for both channels. Each channel has a separate built-in thermal sensor and separate logic circuitry. If one channel heat sink reaches an operating temperature of 60° C, then its logic will cause high-speed fan operation regardless of the other channel's operating temperature. In other words, either channel heating will control the fan speed. Under normal continuous usage at full-rated power output into the rated load, the thermal logic system will continuously monitor heat sink temperatures and will automatically select the fan speed required to maintain safe operating limits for the power transistors.

HIGH TEMPERATURE LED'S (4)

If the CS-1000 is continuously operated into 2 ohm loads or lower for any considerable length of time or if the ambient temperature of the air supply were to become too hot to provide adequate cooling even under normal 4 ohm loading situations, then the amplifier internal heat sinks could reach unsafe operating temperatures. When this occurs, then the thermal logic system will shut down the unsafe channel, causing the high temperature LED to light and the "0" LED to go out on that channel. Since the CS-1000 is a redundant amplifier, the shutdown of one channel will not affect the operation of the other channel. After the unsafe channel cools down to safe limits, operation will be restored in that channel. Normal operation will be indicated by the high temperature LED off and the "0" LED on. Continued operation under fault conditions will in no way harm the amplifier, but because of the nuisance factor, steps should be taken to determine the problem and solve it. Because of the very efficient design of the CS-1000 dissipation system, thermal shutdown conditions will almost never occur unless there is truly an external fault. For continuous operation, the CS-1000 requires a source of cool air. As an added help in locating mismatched or shorted speakers, the DDT active LED is a powerful tool. If this LED flashes continuously at relatively low output power levels (indicated by low power readings on the LED array), it is almost a sure sign that the amplifier loading is too low in value or that there might be a short. Remember, usually the power LED array should reach 100% indication before the DDT system is activated on any particular channel.

The CS-1000 also has a fail-safe thermal mechanism built into the unit. If either channel thermal logic system should fail to cause thermal shutdown in that channel or if the fan itself should fail, then this fail-safe system will shut down the entire amplifier, just as if you had turned off the power switch. This is just one more protection that Peavey has incorporated into this unique amplifier as a backup system. If this should ever occur, immediately seek professional help at a Authorized Peavey Service Center.

MAINS POWER SWITCH (5)

The front panel of the CS-1000 contains a conventional type on/off rocker switch. When the amplifier is plugged into a suitable power source, activating this switch should light both channel "0" array LED's after the power-up delay sequence is completed (approximately two

seconds). You should also be able to hear the output relays close (click). If the amplifier is cool, the fan should start on low speed operation. If only one channel "0" indicator lights, then the possibility exists that the mains fuse has blown. If neither channel "0" indicator lights, then check the main power source. It's always a good idea to check to see that the fan is operational, especially on a new unit. The possibility exists that due to shipping and handling, the fan bearings might be too tight to allow low speed fan operation. If this is the case, immediately seek professional help. The CS-1000 must have normal fan operation to provide adequate cooling for the unit. Without airflow, the amplifier will "thermal" very quickly under any signal conditions.

BACK PANEL

The back panel of the CS-1000 contains a "back porch" design which contains the various input and output connectors for each channel. Also included is the patch panel to provide the user with a very flexible system to facilitate the use of balanced input transformers and dual crossover networks. These features are unduplicated in any other stereo power amp on the market today. The back panel also includes the fan opening with protective grille (6) where cooling air is drawn into the amplifier. This opening should never be blocked or restricted.

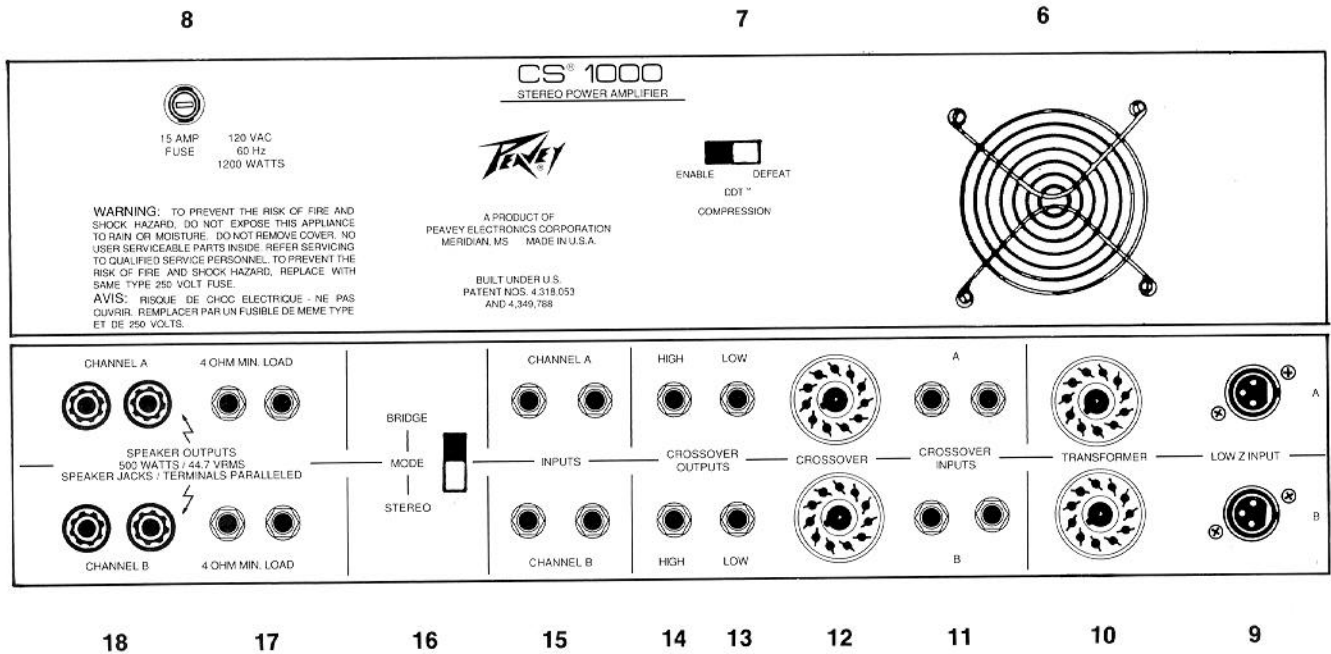

FUSES (8)

The CS-1000 is fused with a standard 15 amp, 125 VAC fuse. Always replace with the same type and rating. Failure to do this could void the warranty on the CS-1000.

MODE SWITCH (16)

The mode switch is located on the "back porch" next to the channel input jacks. This switch converts the CS-1000 from normal stereo mode to bridge mode. Unless the amplifier is to be used in a commercial sound distribution system (70/100 volt lines), the bridge mode should not be used. In certain crossover applications, accidental switching to the bridge mode could destroy the speaker system. Applications of the bridge mode will be covered later in this manual.

PATCH PANEL

The patch panel of the CS-1000 offers many features that make the amplifier more flexible. In order to simplify the explanation, four basic modes of operation will be introduced. Simplified functional diagrams are printed on the top of the CS-1000 showing these four modes. These diagrams also appear in this manual for discussion purposes.

1 CS-1000 PATCH PANEL (STEREO MODE) WITH JUMPERS

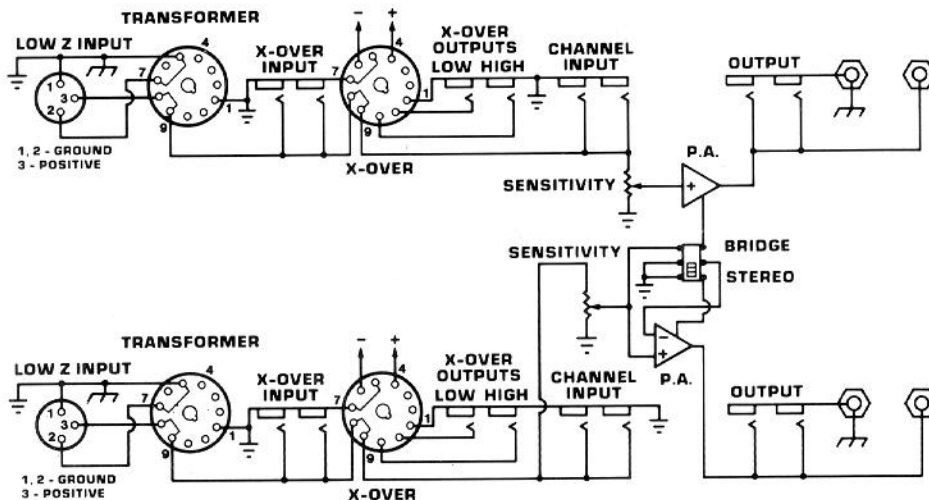

STEREO MODE (UNBALANCED INPUTS) (9) (10) (12) (15)

The CS-1000 is shipped from the factory with jumper plugs inserted in the transformer (10) and crossover (12) accessory sockets. These jumper plugs are necessary if the low impedance connectors (9) are to be used as inputs for each channel. As indicated in Diagram 1, the XLR connectors are wired in an unbalanced configuration (pins 1 and 2 are ground, pin 3 is input). The unbalanced input configuration is acceptable whenever relatively short cable runs are employed or when the associated mixer used has a transformer-coupled output. Under these circumstances, this configuration will usually provide adequate hum and interference rejection for most environments. Notice that the jumper plugs in the crossover accessory sockets are required to complete the signal patch to the respective power amp inputs (15). If the normal unbalanced 1/4" power amp input jacks are used instead, then the jumper plugs are not necessary. It is suggested, however, that they be left in their respective sockets for possible later usage. As with all Peavey amplifiers, the CS-1000 has two power amp input jacks per channel (15), which offer considerable flexibility in hook-up possibilities. For monaural operation (the same signal is applied to both channels), the mixer output is plugged in one of the parallel input jacks in one of the channels and a short shielded jumper cable is then connected between the remaining input jack on that channel to one of the parallel input jacks on the other channel. This technique is called daisy-chaining and can be repeated many times to include additional amplifier channels requiring the same signal feed.

STEREO MODE (BALANCED INPUTS) (9) (10) (15)

When conditions require the use of a balanced input at the amplifier, the XLR connectors (9) on either or both channels can be converted to a balanced configuration by removing the jumper plug from the transformer accessory socket (10) and plugging in an input transformer module (PL-2). The Peavey model PL-2 transformer module is a nominal 1:1 turn ratio-type, resulting in unity gain. As indicated in Diagram 2, the XLR connector is now wired as a conventional balanced-type input (pin 1 is ground, pin 2 is negative, pin 3 is positive). Again, the jumper plugs in the crossover accessory sockets are required to complete the signal patch to the respective power amp inputs (15). If balanced stereo operation is desired, then two PL-2 modules are required. However, for monaural operation, only one PL-2 is needed, and the inputs are connected together by placing a short shielded jumper cable between one of the power amp input jacks (15) on each channel. Obviously, the XLR connector associated with the transformer module is the balanced system input and the other XLR connector is not used.

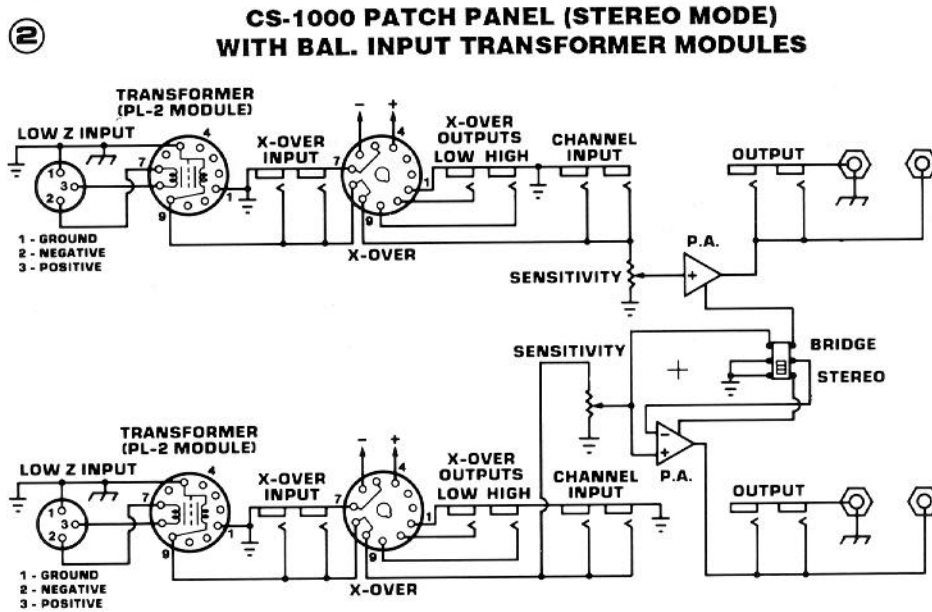

BIAMPING

The Peavey CS-1000 patch panel can also be used to biamp and/or provide special equalization capabilities for loudspeaker systems. Various electronic crossovers and special purpose modules are available in a broad range of frequencies for both Peavey and non-Peavey loudspeaker systems. More complicated systems, such as stereo biamped, triamped, or even 4-way crossover systems are possible. We suggest you contact your Authorized Peavey Dealer for details. A typical stereo biamp system will be discussed in this manual.

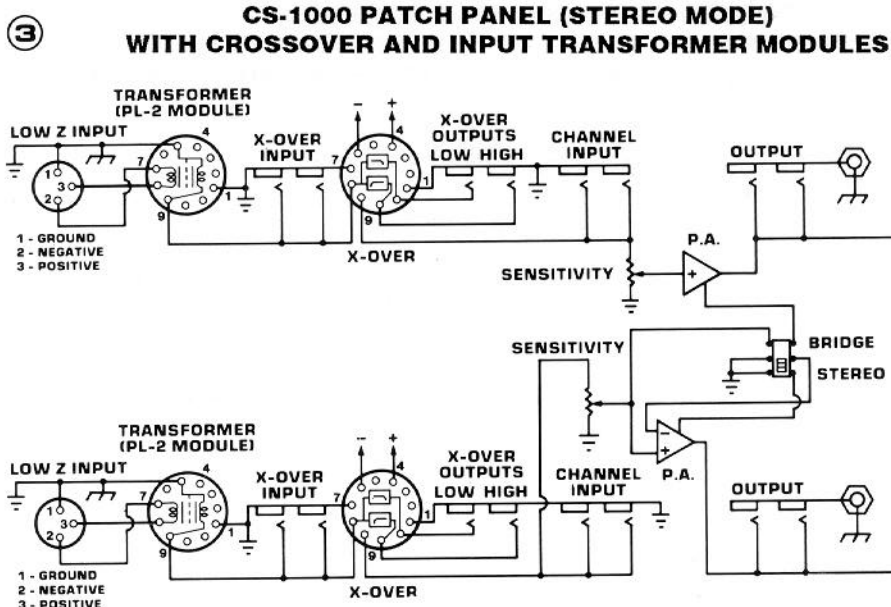

The purpose of a traditional high-level passive crossover found inside most speaker systems is to separate the low frequency material from the program and feed it to the woofer (low frequency driver), and to separate the high frequency material from the program and feed it to the tweeter (high frequency driver). This crossover is connected between a power amplifier and the speakers and, as its name implies, is made up entirely of passive components (no transistors or tubes). Such a system is usually referred to as "full-range," which simply means that the power amplifier must handle the full range of frequencies. There are many good reasons for using a biamplified professional system as opposed to a full-range system. One reason is that the biamp system will provide more headroom with the same power amplifier complement than that of the full-range system. The term headroom deserves some consideration. Program material (music or speech) is made up of many different frequencies and their harmonics. Most music, especially contemporary rock music, is bass heavy. That is, the low frequency material contains much more energy than the high frequency material. If both high and low frequency material, such as voice and bass guitar, are present in a full range system, the high-energy bass frequencies can use up most of the power available from the power amplifier, leaving little (or none) for the high frequencies. The result can be severe clipping (distortion) of the high frequency material. In a biamplified system, the high frequency material is routed to its own power amplifier (and associated loudspeaker), which avoids the clipping problem. This results in an effective increase in system headroom that is greater than would be obtained by simply using a second power amplifier/speaker combination in full range operation. To biamp then, some type of active crossover is employed in the mixer feed to separate the low and high frequency material, which is then patched to separate power amplifiers to drive separate loudspeaker components. Such a system is easily accomplished with the Peavey CS-1000 power amplifier patch panel and associated CS® Series plug-in active crossover modules.

Referring to Diagram 3, the jumper plugs in both crossover accessory sockets (12) have been replaced by two-way crossover modules. Also notice that the PL-2 transformer modules are still in the transformer accessory sockets (10). This configuration now has the makings of a complete stereo-balanced biamp system. The only thing required is an additional stereo power amplifier, which, together with the existing dual power amp sections of the CS-1000, makes up the four independent power amplifiers required for a stereo biamplification system. You will notice that because of the pin out arrangements of the jumper plugs versus the crossover networks, whenever the jumper plugs are removed from the crossover accessory sockets (12), the power amplifier inputs for the respective channels are isolated (no longer connected to anything). In other words, the crossover modules themselves and all associated connectors (as well as the PL-2 transformers and respective XLR connectors) are islands unto themselves. In this case, two islands with each crossover having a balanced input (9), dual (parallel) unbalanced inputs (11), an unbalanced low output (13), and an unbalanced high output (14). In order to complete the system, external patching must be accomplished between the low and high crossover outputs and the various power amp inputs using shielded patch cords.

Reviewing our previous discussion concerning headroom, bass-heavy program material requires more power for the low frequency system than the high frequency system. In general, high frequency horn drivers have lower power ratings (power handling capability), but have high efficiency ratings (sound pressure capability for a given power) than do low frequency woofers. Thus, it might be necessary to use a smaller power amplifier on the high frequency components and a larger power amplifier on the low frequency components of a biamp system. Such a system can be achieved using the CS-1000 stereo power amplifier itself for the two low frequency channels, and adding a Peavey M-7000 for the two high frequency channels. In this case, the low outs (13) of the crossover islands must be patched to the power amp inputs (15) of the CS-1000, and the high outs (14) of the crossover islands must be patched to the power amp inputs of the M-7000. Four shielded patch cords are required in this configuration. The stereo feeds from the associated mixing system will be patched into the balanced XLR connectors (9) on the respective crossover islands. The system is then completed by connecting the proper speaker components to the correct power amplifier outputs. A diagram is included at the end of this manual showing all connections. It is recommended that all connections be completed and double-checked before applying power. Wrong connections could result in loudspeaker damage. It is also good practice to apply AC power to the power amplifiers with the sensitivity controls at full counter-clockwise settings (off) and then gradually bring up the levels to check connections and make sure at low sound pressure levels that the biamped system has proper routing of highs and lows to the respective amps, horns and bass enclosures. After completion of these tests, the various sensitivity controls should be set to their normal operational settings (usually full clockwise).

Obviously, for a monaural biamp system (only one mixer feed), only one crossover module is required and only one crossover island will be used. In this case, one channel of the CS-1000 can be patched for the lows and the other channel patched for the highs, resulting in a simple, compact system with outstanding performance. Again, a word of caution is in order. Since the CS-1000 is capable of producing more than 500 watts RMS per channel into a 4 ohm load, the high frequency components of the particular loudspeaker system must be able to handle these power levels. Alternatives are to use a smaller power amplifier for the entire biamp system, such as the M-7000 or M-4000, which offer the same features as the CS-1000.

The Peavey DDT compression system adds a new dimension to biamped systems. Each power amplifier channel has its own Distortion Detection Technique circuitry, and each is completely independent. When signal conditions exist which could cause clipping in the low frequency power amp channel(s), the DDT system will simply limit that portion of the total biamp system. This will in no way affect the high frequency portion of the biamp system and it is free to increase in level until conditions exist which could cause clipping in that particular power amp channel(s). At that point, the DDT system will limit the high frequency portion of the system. This is a very effective two-level compression system and will yield sound pressure levels unmatched by conventional broad-band compression techniques.

The Peavey CS-1000 offers maximum flexibility and performance features not found on most competitive units. By thoroughly understanding the patch panel features, expansion to larger and more complex systems is only limited by the imagination of the user. Toward this end, we offer the following additional information which may or may not be obvious:

1. A biamp approach is only possible with loudspeaker systems which provide access to the individual speaker components, bypassing the built-in passive crossover (most Peavey loudspeaker systems offer biamp high and low switching jacks on the back panel).
2. The crossover module used must have the proper characteristics to match the particular loudspeaker system. Of greatest importance is the crossover frequency. Peavey offers a variety of plug-in crossover modules which are specifically designed to match the various loudspeakers in the product line. These crossovers have the correct crossover frequency, high frequency pad and equalization for the particular loudspeaker, resulting in system performance with a very flat frequency response. Also available are general purpose crossover modules at frequencies of 500, 800, and 1200 Hz for non-Peavey loudspeaker systems.
3. The outputs of the crossover modules (both high and low) can drive several power amp inputs. The parallel input jacks can be used to daisy-chain to additional power amps for an expanded system on either the low or high frequency system (or both). Remember, the components in most Peavey biampable speaker systems are 8 ohms. All Peavey CS series power amplifiers are rated at 4 ohms. This means that the maximum number of components connected to any one particular power amplifier channel is two (two horns, two woofers). If additional components are required for additional coverage or projection, then additional power amp channels are required.
4. The PL-2 transformer module can be removed and the jumper reinstalled in any particular crossover island if a balanced input is not desired or required for the crossover module. In this case, the associated XLR connector (9) is now unbalanced as per previous discussion. If desired, the parallel unbalanced phone jack inputs (11) may be used to supply signal to the crossover module. In addition, whenever the XLR connector on a particular crossover island is used (either balanced or unbalanced), the crossover input jacks (11) can be used to patch out full range signals to other amplifier/speaker systems which are operating in full range or other biamped systems which required different crossovers.

4

CS-1000 PATCH PANEL (BRIDGE MODE) WITH JUMPERS

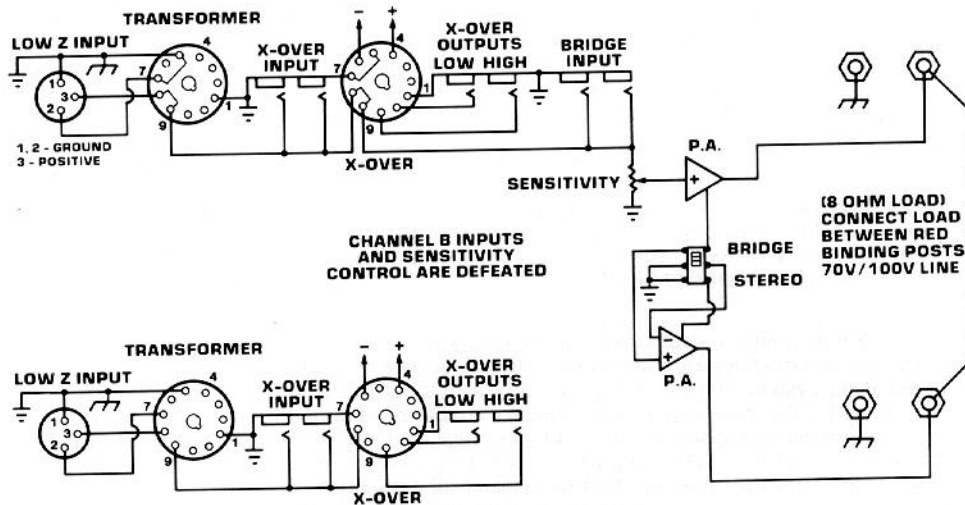

- Care must be taken to never remove a crossover module or replace it with the CS-1000 power switch on. The complex circuitry used in the crossover modules receives bipolar power through the socket, and removal or replacement could cause severe transients which can destroy the loudspeaker system. Always turn the CS-1000 off first. As an added feature, the bipolar power for the crossover islands can be supplied from either channel of the CS-1000. Thus, if one channel should shut down for any reason, the redundancy of the system will maintain operation of the crossovers.
- The individual sensitivity controls on each channel play a very important role in the use of the crossover modules. As such, they represent a signal loss when they are operated at another setting other than full clockwise (maximum sensitivity). Biamped speaker systems usually require less signal level for the high frequency components because they are generally more efficient. Consequently, a system balance can be achieved by reducing the high pass level. This is particularly important on non-Peavey loudspeakers where the PL-500, PL-800 or PL-1200 crossover modules must be used. These modules are referred to as "no pad and equalization" types. As such, there is no reduction in high pass level. Consequently, the pad must be accomplished using the high pass channel sensitivity control. The amount of pad required is always the difference between the efficiency ratings of the high and low speaker components. Whenever Peavey loudspeakers are operated using the special crossovers the sensitivity controls should be set at full clockwise settings (maximum sensitivity) to provide maximum system headroom since the correct pad and equalization is already provided in the crossover module.

Bridge Mode

The bridge mode on stereo amplifiers is often misunderstood as to the actual operation and usage. In basic terms, when a two-channel amplifier is operated in the bridge mode, it is converted to a single-channel unit with a power rating equal to the sum of both channels' continuous power ratings, at a load rating of twice that of the single-channel ratings. For the CS-1000, the bridge ratings are 1000 watts RMS (continuous) into 8 ohms (minimum load). Bridge mode operation is accomplished by placing the mode switch (16) in the bridge position, connecting the load between the red binding posts of each channel, and using Channel A as the input channel. All functions of Channel B as an input are defeated. What actually happens from the technical standpoint is that Channel B is supplied an input signal which is equal in level but is 180° out-of-phase from that of the Channel A input signal (i.e., when Channel A's signal is positive, Channel B's signal is negative and vice versa). Thus, the load (which is connected between the channels) sees the sum of the output voltages of both channels (which is then twice that of the single channel), and this load must be 8 ohms or greater.

For the CS-1000, the selection of bridge mode should invoke the following interesting question: "Where would I need a 1000 watt, 8 ohm amplifier?" When you consider the fact that there are virtually no 8 ohm speaker components which can handle 1000 watts RMS (continuous) safely, there are generally no practical applications for a bridged CS-1000 in simple sound systems. The real purpose is to drive sound distribution systems in very large public address applications. In the bridge mode, the CS-1000 can supply 70 or 100 volts RMS directly without matching transformers. 70 volt distribution systems are very common in domestic applications where large numbers of relatively small loudspeakers are used for background music and paging. Such systems require the use of 70 volt transformers at each loudspeaker. 100 volt systems are more common in export applications. Occasionally a large speaker array might require (or handle) 1000 watts RMS into 8 ohms directly. This then might be a practical application.

Diagram 4 shows the actual arrangement for the CS-1000 patch panel in the bridge mode. Notice the jumper plugs are inserted in the transformer (10) and crossover (12) accessory sockets of Island A. These jumper plugs cause the XLR connector of this island to be wired in the unbalanced configuration (as in Diagram 1) and complete the connection to the parallel bridge power amp input jacks (formerly Channel A power amp input). The Channel A sensitivity control now determines the sensitivity of the bridge mode amplifier. The Channel B power amp input jacks and sensitivity control have been deleted since they serve no purpose in this mode and are actually electronically removed from the circuit. Both sets of parallel ¼" output phone jacks have been deleted on the diagram since these also are normally not used in the bridge mode. Remember, the 8 ohm minimum load must be connected between the red binding posts. If individual 4 ohm loads were connected to each output (as in normal stereo applications) when the bridge mode is selected, Channel A would supply a normal in-phase signal to its respective load, but Channel B would supply an abnormal out-of-phase signal to its respective load, and both of these signals would be the Channel A source material (Channel B source material, if present, would be defeated). This is a very dangerous situation, especially if the individual channels are being used to supply high and low signals in the typical biamp configuration. Obviously, the speaker components on Channel B would no longer be supplied their intended signal but rather an out-of-phase version of the Channel A signal, which could destroy the associated loudspeaker components. To minimize the possibility of this happening on the CS-1000, whenever the bridge mode is selected, the standby ("0") LED and the LED array itself on Channel B is defeated (off), just as if there was a fault condition on Channel B. This provides a positive indication that the CS-1000 is no longer in the stereo mode.

Often technicians fall into what we call "the bridge syndrome." This is designing a system for bridge mode operation when indeed they really don't need it. A typical example is where two 4 ohm speaker enclosures are wired in series, creating an 8 ohm load, and this load is then driven in bridge mode. In this case, a CS-1000 would deliver 500 watts RMS to each enclosure (a total of 1000 watts for both). A much better

approach is to use the CS-1000 in the stereo mode and then connect one 4 ohm speaker enclosure to each channel of the CS-1000 and daisy-chain the inputs. Each channel would still deliver 500 watts RMS to each enclosure (a total of 1000 watts for both), but now you would have a redundant system with the advantage of being able to adjust the individual levels if that is a desirable feature. Another frequent application problem is driving a single 4 ohm enclosure in bridge mode. This is simply an example of not understanding that when bridge mode is selected, the rated load specification is twice that of single channel operation. In this case, under continuous full power operation the amplifier will thermal out.

Although bridge mode operation is very easy to accomplish on the CS-1000, and we have provided an indication means whenever the mode is selected, again, a thorough understanding of the patch panel features will allow further expansion to more complex systems. The following list should provide more information toward these goals:

1. For proper bridge mode operation, both wires of the output must "float" above ground. If either wire were to become grounded, this would present a short circuit to the associated channel of the CS-1000. As an aid in determining the condition of the distribution system, the DDT activation LED's on both channels are operational when the bridge mode is selected. Whenever the CS-1000 reaches full power output, both DDT activation LED's should flash simultaneously, indicating that DDT compression is taking place in both channels. This is a normal indication, since in bridge mode with normal loading, both channels should reach full power simultaneously. If the DDT activation LED on one channel flashes at a much lower signal level than that of the other channel, this indicates that the bridge loading is not balanced and that one leg may have become shorted to ground. In this case, steps should be taken to locate the problem and clear it. If both LED's flash at relatively low output power levels, then this indicates that the total bridge loading is too low in value or possibly shorted across itself. Remember, just as in the stereo mode, the power LED array (Channel A) should reach 100% indication before the DDT system is activated on both channels.
2. The jumper plug in the transformer accessory socket (10) of channel A island can be replaced with a PL-2 transformer module. This will convert the XLR connector on Island A to balanced operation and provide a balanced input for the bridged CS-1000.
3. The jumper plug in the crossover accessory socket (12) of the Channel A island can be replaced with a crossover or other special purpose plug-in module. As per previous discussion, the associated bridge power amp input jacks (12) are now isolated, and signals must be patched to this bridge input to complete the circuit. Obviously, in bridge mode the CS-1000 is only a one-channel amp. Consequently, to biamp, additional power amplifier channels must be available. Again, a word of caution concerning the power handling capability of the associated loudspeaker components in order. Unless the components are part of an array connected in some series/parallel arrangement to distribute the power, biamping with the CS-1000 in bridge mode (1000 watts) should be avoided.
4. You should notice from Diagram 4 that crossover island B is completely isolated whenever bridge mode is selected, and it is normally not used. However, it can be used with additional plug-in modules for expanded and more complicated systems. These additional patches we will leave to the imagination of the user.

As you can see, the CS-1000 is a very flexible amplifier. We highly recommend that you become thoroughly familiar with every aspect of operation before connecting any speaker system to it. Pay particular attention to the functions of the patch panel and load impedance. We have included several patch diagrams for information purposes.

Attention Mr. Service Technician: If the time should ever come for you to zero problems gaining access to the heat tube itself and all the associated circuitry. Our Service Department stands ready to help you if needed with additional instructions on the correct service parts. **Warning:** There are no user serviceable parts or functions inside the amplifier. Disassembly should only be attempted by a qualified Peavey service technician, and only after the amplifier has been disconnected from the mains power source.

Warning: Voltage levels inside this amplifier could cause severe bodily harm. Always disconnect unit from mains power source and discharge major electrolytic capacitors before attempting to service. Additionally, the mains power source is switched by a mains triac which is controlled by the front panel rocker switch. Mains power voltage is always present at this triac even with the switch off.

CS®-1000 SPECIFICATIONS

RATED OUTPUT POWER:

300W RMS per channel into 8 ohms
500W RMS per channel into 4 ohms
(Both channels driven)
1000W RMS into 8 ohms
(Bridge mode)
(Continuous sine wave with less than 0.03% THD, 20 Hz to 20 kHz,
120V AC)

POWER @ CLIPPING (Typical):

330W RMS per channel into 8 ohms
550W RMS per channel into 4 ohms
350W RMS per channel into 2 ohms
(Both channels driven)
1100W RMS into 8 ohms
(Bridge mode)
(Continuous sine wave with less than 1% THD, 20 Hz to 20 kHz,
120V AC)

TOTAL HARMONIC DISTORTION

Less than 0.05% @ 500W RMS per channel into 4 ohms, 10 Hz to
30 kHz
(Typically below 0.03%)

FREQUENCY RESPONSE

+0, -0.2 dB @ 500W RMS per channel into 4 ohms, 20 Hz to 40 kHz
+0, -1 dB @ 1W RMS per channel into 4 ohms, 5 Hz to 60 kHz

POWER BANDWIDTH

10 Hz to 50 kHz @ 500W RMS per channel into 4 ohms, less than
0.1% THD

SLEW RATE

50 Volts/microsecond
(Stereo mode, each channel)
90 Volts/microsecond
(Bridge mode)

DAMPING FACTOR:

Greater than 200 @ 4 ohms; 400 @ 8 ohms
(Stereo mode, each channel, f = 1 kHz)

HUM & NOISE:

100 dB below full rated power
(Stereo mode, each channel or bridge mode, 20 Hz to 20 kHz,
unweighted)

DIMENSIONS:

19" W × 5¼" H × 14¼" D

WEIGHT:

53 lbs.

CS-1000 PATCH DIAGRAMS

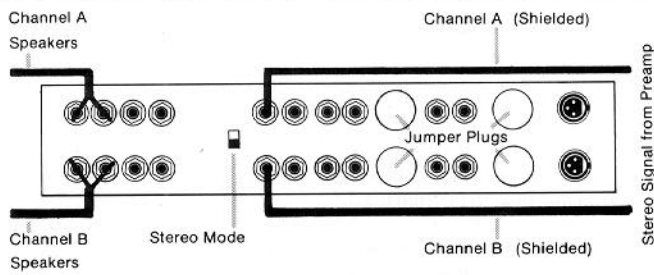

CS-1000

PATCH DIAGRAM 1

Stereo Operation
Unbalanced High Z Inputs
(Typical Home Stereo)

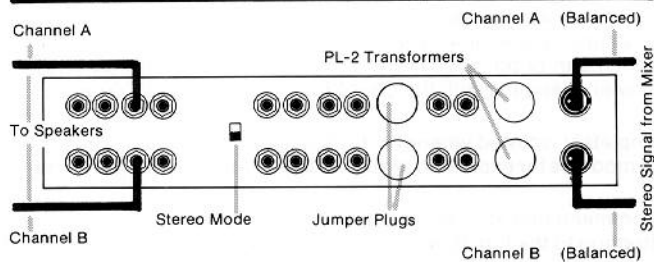

CS-1000

PATCH DIAGRAM 2

Stereo Operation
Balanced Low Z Inputs

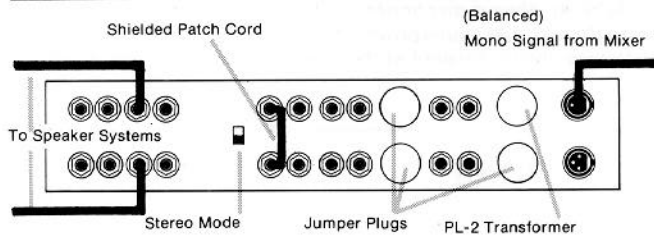

CS-1000

PATCH DIAGRAM 3

Monaural Operation
Balanced Low Z Inputs
(Jumped Inputs)

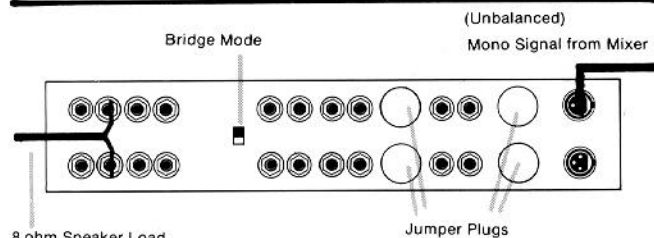

CS-1000

PATCH DIAGRAM 4

Bridge Mode Operation
Unbalanced Low Z Input
(Pin #3 Input)

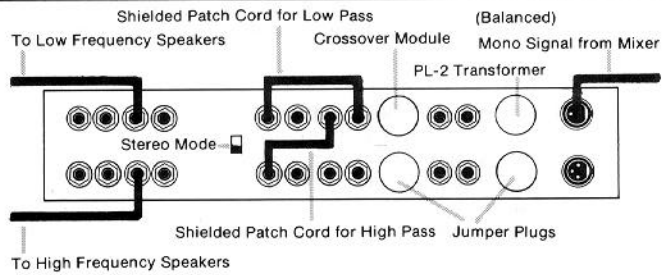

CS-1000

PATCH DIAGRAM 5

Biamp Operation
Balanced Low Z Input
(Monaural Signal)

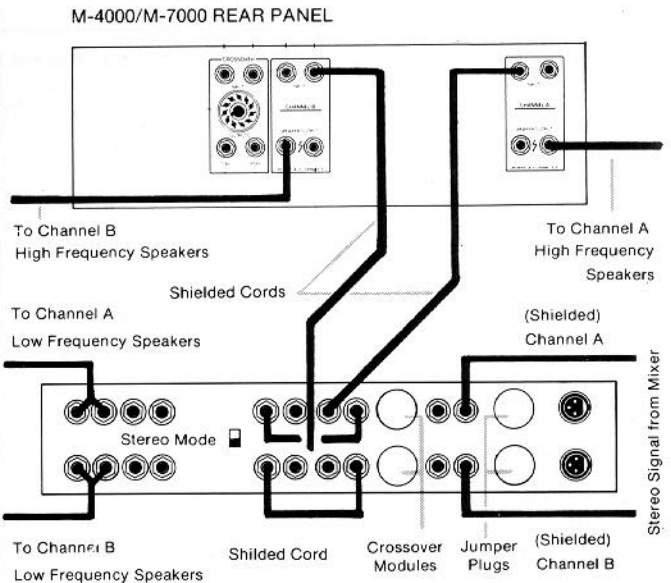

CS-1000

PATCH DIAGRAM 6

Biamp Operation
Unbalanced High Z Inputs
(Stereo Signal)

THIS LIMITED WARRANTY VALID ONLY WHEN PURCHASED AND REGISTERED IN THE UNITED STATES OR CANADA. ALL EXPORTED PRODUCTS ARE SUBJECT TO WARRANTY AND SERVICES TO BE SPECIFIED AND PROVIDED BY THE AUTHORIZED DISTRIBUTOR FOR EACH COUNTRY.

Ces clauses de garantie ne sont valables qu'aux Etats-Unis et au Canada. Dans tous les autres pays, les clauses de garantie et de maintenance sont fixées par le distributeur national et assurées par lui selon la législation en vigueur.

Diese Garantie ist nur in den USA und Kanada gültig. Alle Export-Produkte sind der Garantie und dem Service des Importeurs des jeweiligen Landes unterworfen.

Esta garantía es válida solamente cuando el producto es comprado en E.U. continentales o en Canada. Todos los productos que sean comprados en el extranjero, están sujetos a las garantías y servicio que cada distribuidor autorizado determine y ofrezca en los diferentes países.

ONE-YEAR LIMITED WARRANTY/REMEDY

PEAVEY ELECTRONICS CORPORATION ("PEAVEY") warrants this product, EXCEPT for covers, footswitches, patchcords, tubes and meters, to be free from defects in material and workmanship for a period of one (1) year from date of purchase, PROVIDED, however that this limited warranty is extended only to the original retail purchaser and is subject to the conditions, exclusions and limitations hereinafter set forth:

PEAVEY 90-DAY LIMITED WARRANTY ON TUBES AND METERS

If this product contains tubes or meters, Peavey warrants the tubes or meters contained in the product to be free from defects in material and workmanship for a period of ninety (90) days from date of purchase; PROVIDED, however, that this limited warranty is extended only to the original retail purchaser and is also subject to the conditions, exclusions and limitations hereinafter set forth.

CONDITIONS, EXCLUSIONS AND LIMITATIONS OF LIMITED WARRANTIES

These limited warranties shall be void and of no effect if:

- a. The first purchase of the product is for the purpose of resale; or
- b. The original retail purchase is not made from an AUTHORIZED PEAVEY DEALER; or
- c. The product has been damaged by accident or unreasonable use, neglect, improper service or maintenance, or other causes not arising out of defects in material or workmanship; or
- d. The serial number affixed to the product is altered, defaced or removed.

In the event of a defect in material and/or workmanship covered by this limited warranty, Peavey will:

- a. In the case of tubes or meters, replace the defective component without charge;
 - b. In other covered cases (i.e., cases involving anything other than covers, footswitches, patchcords, tubes or meters), repair the defect in material or workmanship or replace the product, at Peavey's option;
- and provided, however, that, in any case, all costs of shipping, if necessary, are paid by you, the purchaser.

THE WARRANTY REGISTRATION CARD SHOULD BE ACCURATELY COMPLETED AND MAILED TO AND RECEIVED BY PEAVEY WITHIN FOURTEEN (14) DAYS FROM THE DATE OF YOUR PURCHASE.

In order to obtain service under these warranties, you must:

- a. Bring the defective item to any AUTHORIZED PEAVEY DEALER or AUTHORIZED PEAVEY SERVICE CENTER and present therewith the ORIGINAL PROOF OF PURCHASE supplied to you by the AUTHORIZED PEAVEY DEALER in connection with your purchase from him of this product.
If the DEALER or SERVICE CENTER is unable to provide the necessary warranty service you will be directed to the nearest other PEAVEY AUTHORIZED DEALER or AUTHORIZED PEAVEY SERVICE CENTER which can provide such service.

OR

- b. Ship the defective item, prepaid, to:

PEAVEY ELECTRONICS CORPORATION
International Service Center
Highway 80 East
MERIDIAN, MS 39301

including therewith a complete, detailed description of the problem, together with a legible copy of the original PROOF OF PURCHASE and a complete return address. Upon Peavey's receipt of these items:

If the defect is remedial under these limited warranties and the other terms and conditions expressed herein have been complied with, Peavey will provide the necessary warranty service to repair or replace the product and will return it, FREIGHT COLLECT, to you, the purchaser.

Peavey's liability to the purchaser for damages from any cause whatsoever and regardless of the form of action, including negligence, is limited to the actual damages up to the greater of \$500.00 or an amount equal to the purchase price of the product that caused the damage or that is the subject of or is directly related to the cause of action. Such purchase price will be that in effect for the specific product when the cause of action arose. This limitation of liability will not apply to claims for personal injury or damage to real property or tangible personal property allegedly caused by Peavey's negligence. Peavey does not assume liability for personal injury or property damage arising out of or caused by a non-Peavey alteration or attachment, nor does Peavey assume any responsibility for damage to interconnected non-Peavey equipment that may result from the normal functioning and maintenance of the Peavey equipment.

UNDER NO CIRCUMSTANCES WILL PEAVEY BE LIABLE FOR ANY LOST PROFITS, LOST SAVINGS, ANY INCIDENTAL DAMAGES OR ANY CONSEQUENTIAL DAMAGES ARISING OUT OF THE USE OR INABILITY TO USE THE PRODUCT, EVEN IF PEAVEY HAS BEEN ADVISED OF THE POSSIBILITY OF SUCH DAMAGES.

THESE LIMITED WARRANTIES ARE IN LIEU OF ANY AND ALL WARRANTIES, EXPRESS OR IMPLIED, INCLUDING, BUT NOT LIMITED TO, THE IMPLIED WARRANTIES OF MERCHANTABILITY AND FITNESS FOR A PARTICULAR USE; PROVIDED, HOWEVER, THAT IF THE OTHER TERMS AND CONDITIONS NECESSARY TO THE EXISTENCE OF THE EXPRESS, LIMITED WARRANTIES, AS HEREINABOVE STATED, HAVE BEEN COMPLIED WITH, IMPLIED WARRANTIES ARE NOT DISCLAIMED DURING THE APPLICABLE ONE-YEAR OR NINETY-DAY PERIOD FROM DATE OF PURCHASE OF THIS PRODUCT.

SOME STATES DO NOT ALLOW LIMITATION ON HOW LONG AN IMPLIED WARRANTY LASTS, OR THE EXCLUSION OR LIMITATION OF INCIDENTAL OR CONSEQUENTIAL DAMAGES, SO THE ABOVE LIMITATIONS OR EXCLUSIONS MAY NOT APPLY TO YOU. THESE LIMITED WARRANTIES GIVE YOU SPECIFIC LEGAL RIGHTS, AND YOU MAY ALSO HAVE OTHER RIGHTS WHICH MAY VARY FROM STATE TO STATE.

THESE LIMITED WARRANTIES ARE THE ONLY EXPRESS WARRANTIES ON THIS PRODUCT, AND NO OTHER STATEMENT, REPRESENTATION, WARRANTY OR AGREEMENT BY ANY PERSON SHALL BE VALID OR BINDING UPON PEAVEY.

In the event of any modification or disclaimer of express or implied warranties, or any limitation of remedies, contained herein conflicts with applicable law, then such modification, disclaimer or limitation, as the case may be, shall be deemed to be modified to the extent necessary to comply with such law.

Your remedies for breach of these warranties are limited to those remedies provided herein and Peavey Electronics Corporation gives this limited warranty only with respect to equipment purchased in the United States of America.

INSTRUCTIONS — WARRANTY REGISTRATION CARD

1. Mail the completed WARRANTY REGISTRATION CARD to:

PEAVEY ELECTRONICS CORPORATION
POST OFFICE BOX 2898
MERIDIAN, MISSISSIPPI 39302-2898

- a. Keep the PROOF OF PURCHASE. In the event warranty service is required during the warranty period, you will need this document. **There will be no identification card issued by Peavey Electronics Corporation.**
2. **IMPORTANCE OF WARRANTY REGISTRATION CARDS AND NOTIFICATION OF CHANGES OF ADDRESS:**
 - a. Completion and mailing of WARRANTY REGISTRATION CARDS — Should notification become necessary for any condition that may require correction, the REGISTRATION CARD will help ensure that you are contacted and properly notified.
 - b. Notice of address changes — If you move from the address shown on the WARRANTY REGISTRATION CARD, you should notify Peavey of the change of address so as to facilitate your receipt of any bulletins or other forms of notification which may become necessary in connection with any condition that may require dissemination of information or correction.
3. You may contact Peavey directly by telephoning (601) 483-5365.
4. Please have the Peavey product name and serial number available when communicating with Peavey Customer Service.

DANGER

EXPOSURE TO EXTREMELY HIGH NOISE LEVELS MAY CAUSE A PERMANENT HEARING LOSS. INDIVIDUALS VARY CONSIDERABLY IN SUSCEPTIBILITY TO NOISE INDUCED HEARING LOSS, BUT NEARLY EVERYONE WILL LOSE SOME HEARING IF EXPOSED TO SUFFICIENTLY INTENSE NOISE FOR A SUFFICIENT TIME.

THE U.S. GOVERNMENT'S OCCUPATIONAL SAFETY AND HEALTH ADMINISTRATION (OSHA) HAS SPECIFIED THE FOLLOWING PERMISSIBLE NOISE LEVEL EXPOSURES:

DURATION PER DAY IN HOURS	SOUND LEVEL dBA, SLOW RESPONSE
8	90
6	92
4	95
3	97
2	100
1 1/2	102
1	105
1/2	110
1/4 or less	115

ACCORDING TO OSHA, ANY EXPOSURE IN EXCESS OF THE ABOVE PERMISSIBLE LIMITS COULD RESULT IN SOME HEARING LOSS.

EAR PLUGS OR PROTECTORS IN THE EAR CANALS OR OVER THE EARS MUST BE WORN WHEN OPERATING THIS AMPLIFICATION SYSTEM IN ORDER TO PREVENT A PERMANENT HEARING LOSS IF EXPOSURE IS IN EXCESS OF THE LIMITS AS SET FORTH ABOVE. TO INSURE AGAINST POTENTIALLY DANGEROUS EXPOSURE TO HIGH SOUND PRESSURE LEVELS, IT IS RECOMMENDED THAT ALL PERSONS EXPOSED TO EQUIPMENT CAPABLE OF PRODUCING HIGH SOUND PRESSURE LEVELS SUCH AS THIS AMPLIFICATION SYSTEM BE PROTECTED BY HEARING PROTECTORS WHILE THIS UNIT IS IN OPERATION.

CAUTION

THIS AMPLIFIER HAS BEEN DESIGNED AND CONSTRUCTED TO PROVIDE ADEQUATE POWER RESERVE FOR PLAYING MODERN MUSIC WHICH MAY REQUIRE OCCASIONAL PEAK POWER. TO HANDLE OCCASIONAL PEAK POWER, ADEQUATE POWER "HEADROOM" HAS BEEN DESIGNED INTO THIS SYSTEM. EXTENDED OPERATION AT ABSOLUTE MAXIMUM POWER LEVELS IS NOT RECOMMENDED SINCE THIS COULD DAMAGE THE ASSOCIATED LOUDSPEAKER SYSTEM. PLEASE BE AWARE THAT **MAXIMUM POWER** CAN BE OBTAINED WITH VERY LOW SETTINGS OF THE **GAIN CONTROLS** IF THE INPUT SIGNAL IS VERY STRONG.

1. Read all safety and operating instructions before using this product.
2. All safety and operating instructions should be retained for future reference.
3. Obey all cautions in the operating instructions and on the back of the unit.
4. All operating instructions should be followed.
5. This product should not be used near water, i.e. a bathtub, sink, swimming pool, wet basement, etc.
6. This product should be located so that its position does not interfere with its proper ventilation. It should not be placed flat against a wall or placed in a built-in enclosure that will impede the flow of cooling air.
7. This product should not be placed near a source of heat such as a stove, radiator or another heat producing amplifier.
8. Connect only to a power supply of the type marked on the unit adjacent to the power supply cord.
9. Never break off the ground pin on the power supply cord. For more information on grounding write for our free booklet "Shock Hazard and Grounding."
10. Power supply cords should always be handled carefully. Never walk or place equipment on power supply cords. Periodically check cords for cuts or signs of stress, especially at the plug and the point where the cord exits the unit.
11. The power supply cord should be unplugged when the unit is to be unused for long periods of time.
12. If this product is to be mounted in an equipment rack, rear support should be provided.
13. Metal parts can be cleaned with a damp rag. The vinyl covering used on some units can be cleaned with a damp rag or an ammonia based household cleaner if necessary.
14. Care should be taken so that objects do not fall and liquids are not spilled into the unit through the ventilation holes or any other openings.
15. This unit should be checked by a qualified service technician if:
 - A. The power supply cord or plug has been damaged.
 - B. Anything has fallen or been spilled into the unit.
 - C. The unit does not operate correctly.
 - D. The unit has been dropped or the enclosure damaged.
16. The user should not attempt to service this equipment. All service work should be done by a qualified service technician.



Features and specifications subject to change without notice.

Peavey Electronics Corporation 711 A Street / Meridian, MS 39302-2898 / U.S.A. / (601) 483-5365 / Telex 504115 / Fax 484-4278